



Bilder Images	Produktgruppen	Product Groups	Rubrik Category
	Vormontagestutzen	Pre-Installation Dies	12.2
	Schmierstoffe	Lubricants	12.3
	- Schmierstoffe	- Lubricants	12.4
	- Schmierstoffe	- Lubricants	12.5
	- Schmierstoffe	- Lubricants	12.6



Stahl - Gehärtet
Für Montage von Hand

Steel - Hardened
For Assembly by Hand

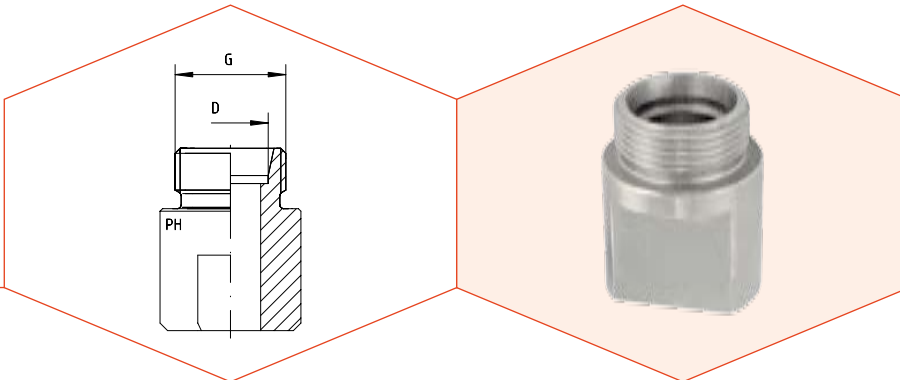
Reihe Series	Rohr A.D. Tube O.D. D	Gewinde Thread G	Bestellzeichen Order-Code	Netto-Preis Net-Price Euro (€)
LL	4	M 8 x 1	VOST-LL-04	37,90
LL	6	M 10 x 1	VOST-LL-06	37,90
LL	8	M 12 x 1	VOST-LL-08	39,35

Reihe Series	Rohr A.D. Tube O.D. D	Gewinde Thread G	Bestellzeichen Order-Code	Netto-Preis Net-Price Euro (€)
L	6	M 12 x 1,5	VOST-L-06	29,70
L	8	M 14 x 1,5	VOST-L-08	29,70
L	10	M 16 x 1,5	VOST-L-10	31,50
L	12	M 18 x 1,5	VOST-L-12	31,50
L	15	M 22 x 1,5	VOST-L-15	35,40
L	18	M 26 x 1,5	VOST-L-18	42,20
L	22	M 30 x 2	VOST-L-22	56,20
L	28	M 36 x 2	VOST-L-28	60,50
L	35	M 45 x 2	VOST-L-35	93,05
L	42	M 52 x 2	VOST-L-42	138,50

Reihe Series	Rohr A.D. Tube O.D. D	Gewinde Thread G	Bestellzeichen Order-Code	Netto-Preis Net-Price Euro (€)
S	6	M 14 x 1,5	VOST-S-06	31,10
S	8	M 16 x 1,5	VOST-S-08	31,10
S	10	M 18 x 1,5	VOST-S-10	31,10
S	12	M 20 x 1,5	VOST-S-12	31,85
S	14	M 22 x 1,5	VOST-S-14	36,15
S	16	M 24 x 1,5	VOST-S-16	41,15
S	20	M 30 x 2	VOST-S-20	54,76
S	25	M 36 x 2	VOST-S-25	56,55
S	30	M 42 x 2	VOST-S-30	95,20
S	38	M 52 x 2	VOST-S-38	133,15

Kein Rabatt!
No discount!

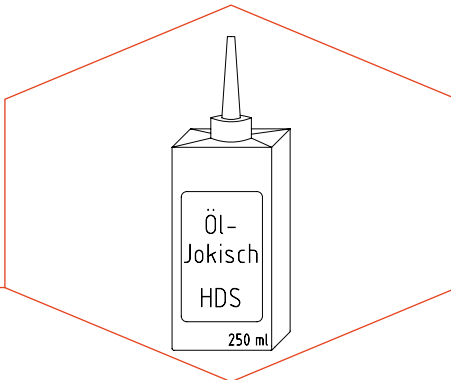

Öl-Jokisch HDS 400 á 250 ml
 Für die Montage von Schraubverbindungen aus Edelstahl
 -20°C bis +120°C

Oil-Jokisch HDS 400 á 250 ml
For Assembly of Stainless Steel Couplings
 -20°C to +120°C

	Bestellzeichen <i>Order-Code</i>	Netto-Preis <i>Net-Price</i> Euro (€)
	Öl-HDS 250 ml	9,70

Kein Rabatt!
 No discount!

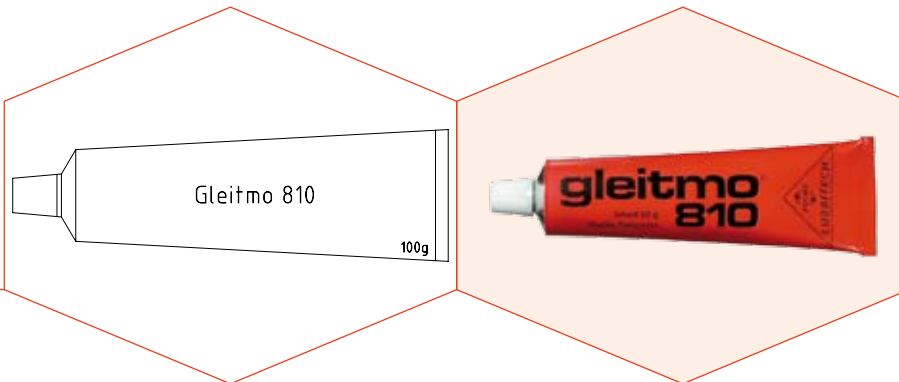

Weißer Paste - Gleitmo 810 á 100 g
Für die Montage von Schraubverbindungen aus Edelstahl
-25°C bis +80°C

White Grease Paste - Gleitmo 810 á 100 g
For Assembly of Stainless Steel Couplings
-25°C to +80°C

	Bestellzeichen <i>Order-Code</i>	Netto-Preis <i>Net-Price</i> Euro (€)
	Gleitmo 810	14,50

Kein Rabatt!
No discount!

PRODUKTE / PRODUCTS

ERLÄUTERUNG / EXPLANATION

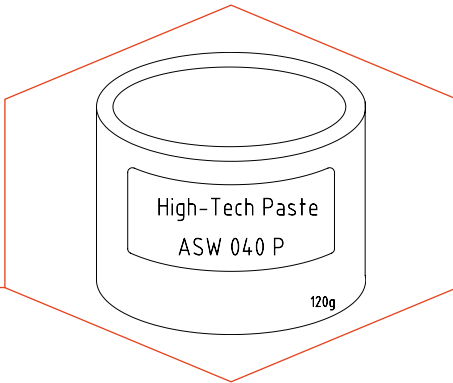

High-Tech Paste ASW 040 P á 120 g - Metallfrei
 Für die Montage von Schraubverbindungen aus Edelstahl
 -40°C bis +1400°C

High-Tech Grease Paste ASW 040 P á 120 g - Metallfrei
 For Assembly of Stainless Steel Couplings
 -40°C to +1400°C

	Bestellzeichen Order-Code	Netto-Preis Net-Price Euro (€)
	ASW 040P-120 g	11,10

Kein Rabatt!
 No discount!

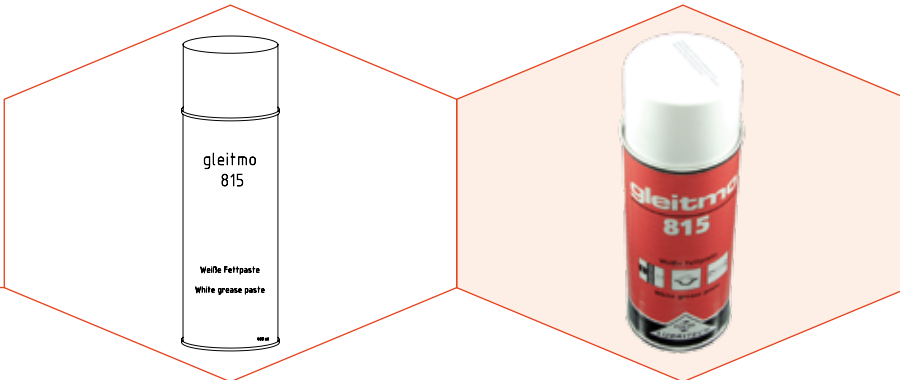

Weiße Fettpaste - Gleitmo 815 - Sprühdose á 400 ml
Für die Montage von Schraubverbindungen aus Edelstahl
-45°C / +110°C; kurzzeitig bis 180°C

White Grease Paste - Gleitmo 815 - Aerosol á 400 ml
For Assembly of Stainless Steel Couplings
-45°C / +110°C; short-term up to 180°C

	Bestellzeichen <i>Order-Code</i>	Netto-Preis <i>Net-Price</i> Euro (€)
	Gleitmo 815	19,85

Kein Rabatt!
No discount!